

S4 OPTIK

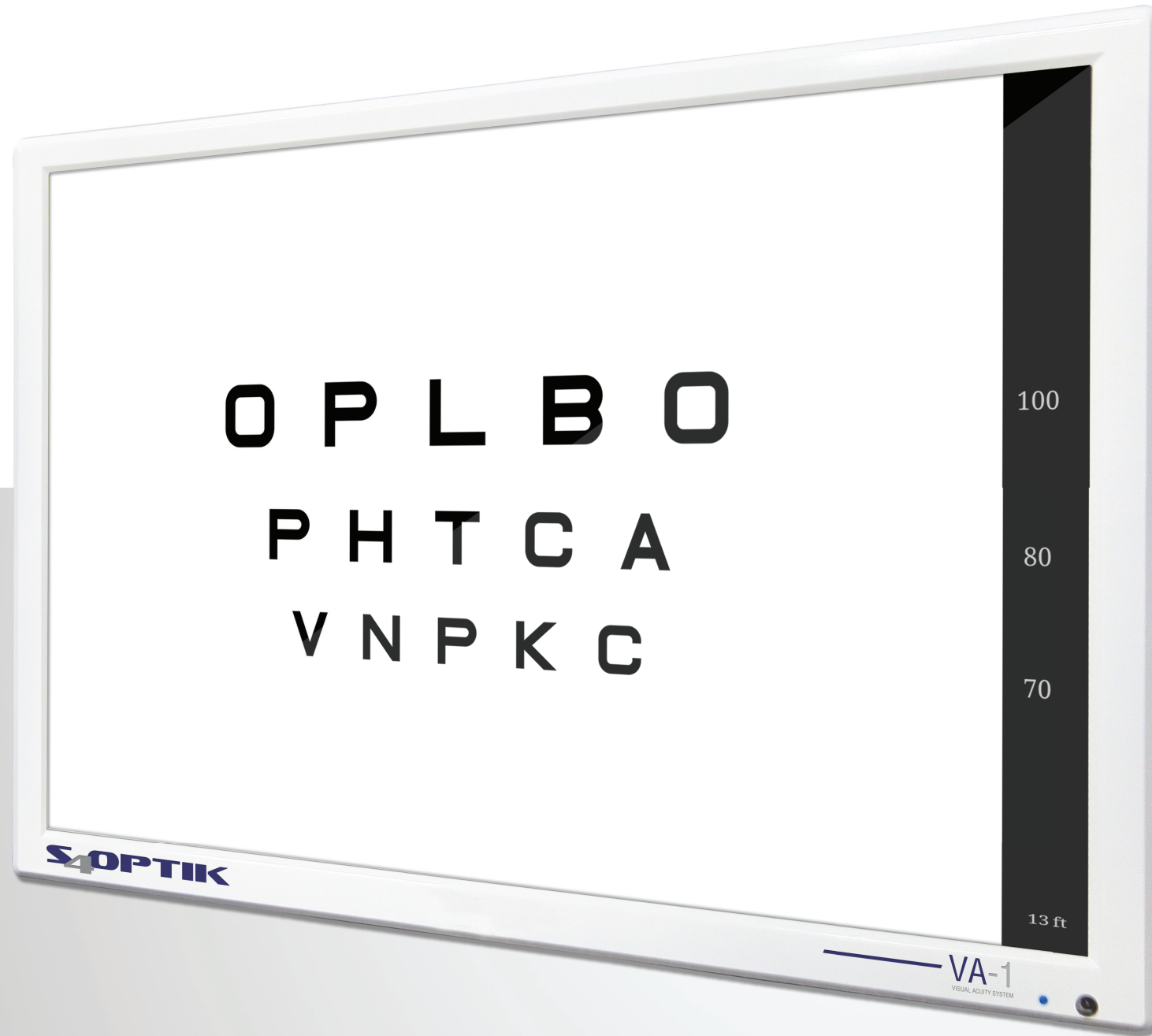

LCD Visual Acuity System VA-1

**Comprehensive Visual
Acuity Solution**

OPTOTYPES

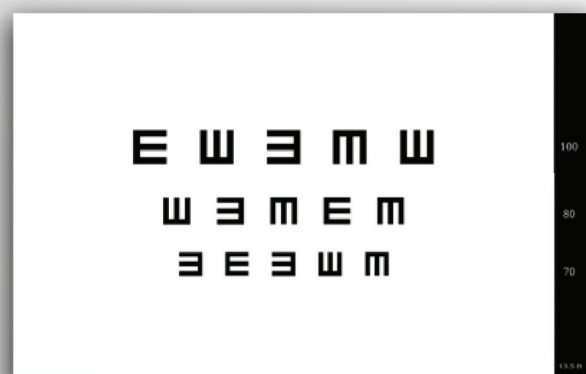
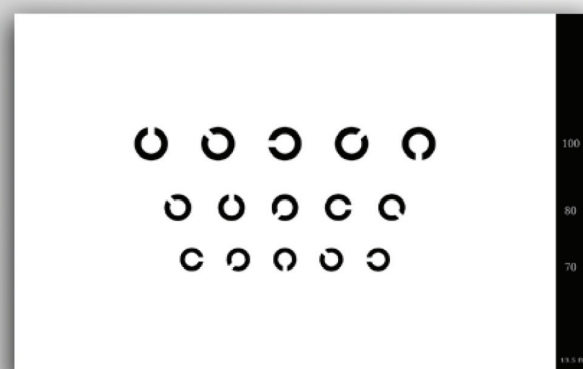
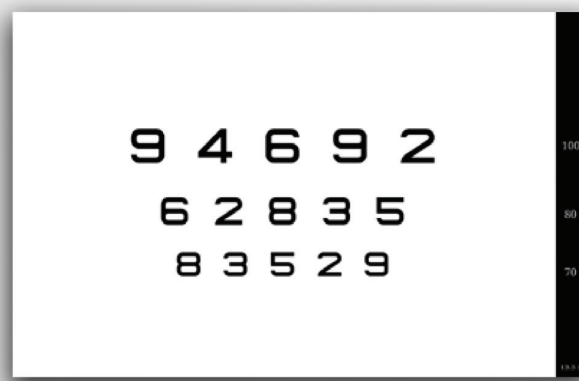
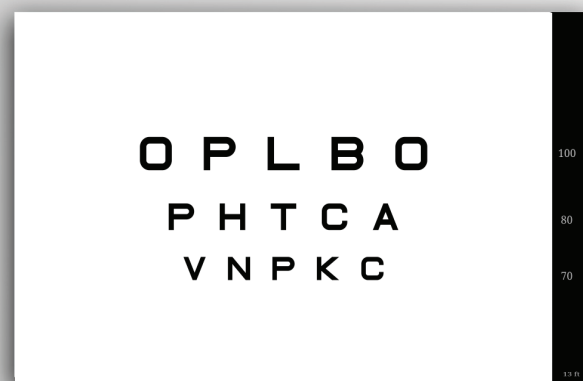

**Comprehensive
selection of
visual acuity**

**ETDRS SPACING PROTOCOL FOR ALL
OPTOTYPES & ACUITY LEVELS**

BINOCULAR TESTS

Stereo, fixation disparity, and aniseikonia tests

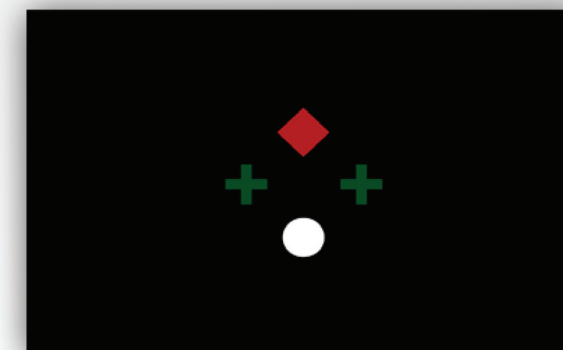

EXTENDED ETDRS CHARTS
 (available for all optotypes)

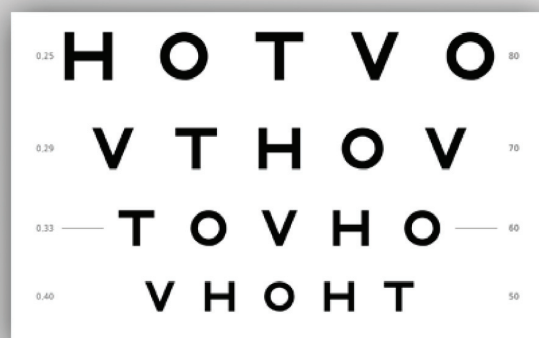

ASTIGMATISM CHARTS

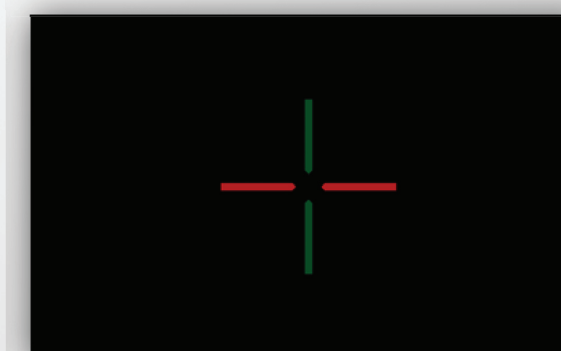
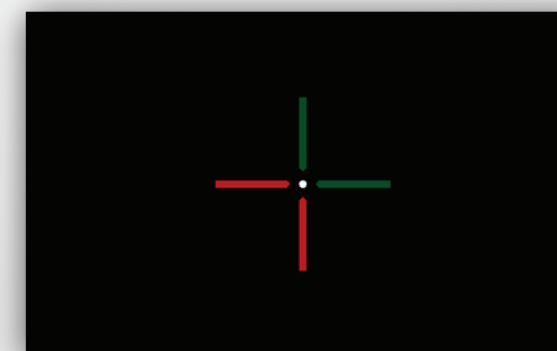
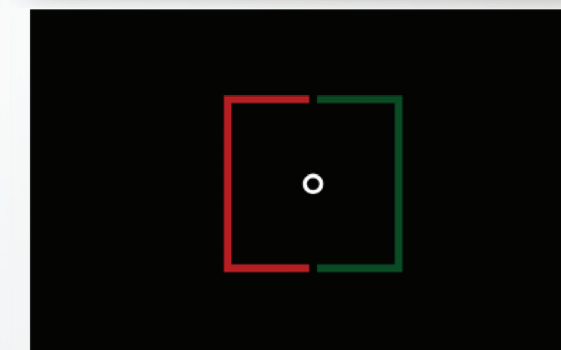
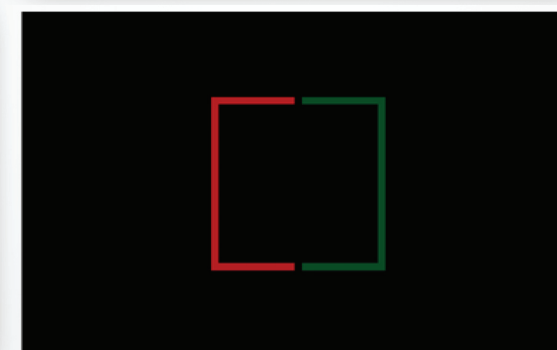
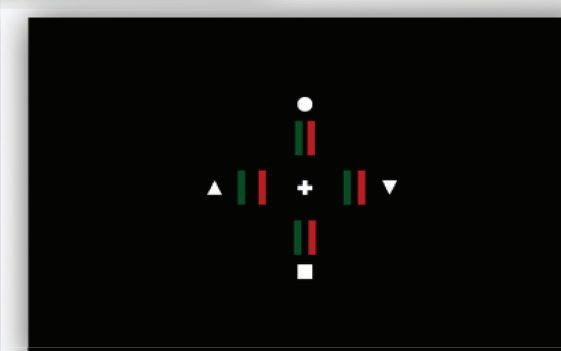
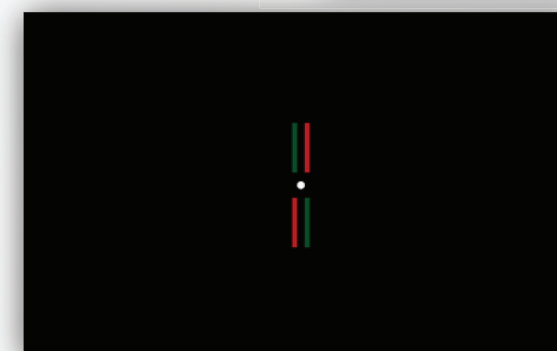
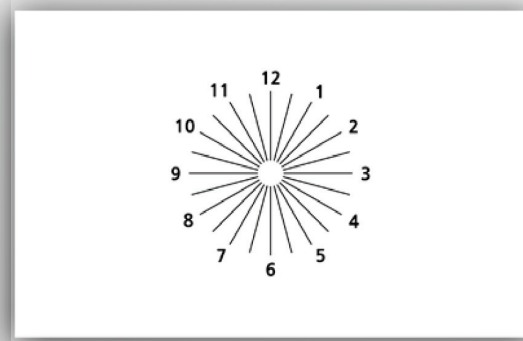
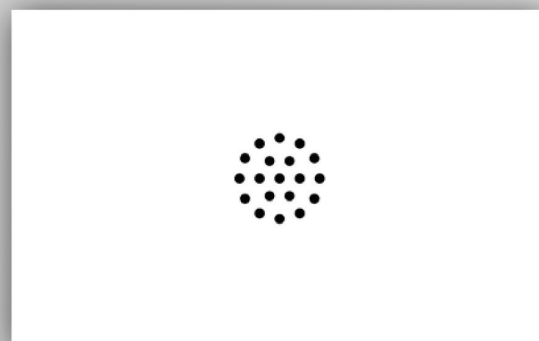

MULTIMEDIA RICH SYSTEM

Animations, Cartoons & Education slides

Optimise for your practice. Upload additional images and videos

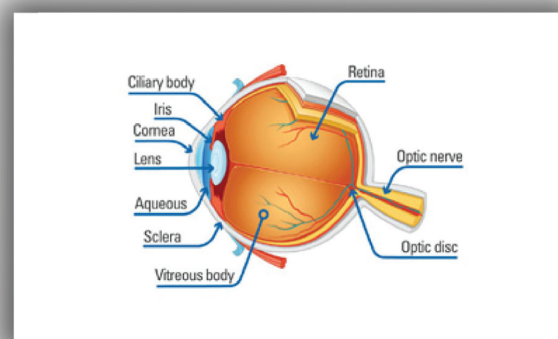
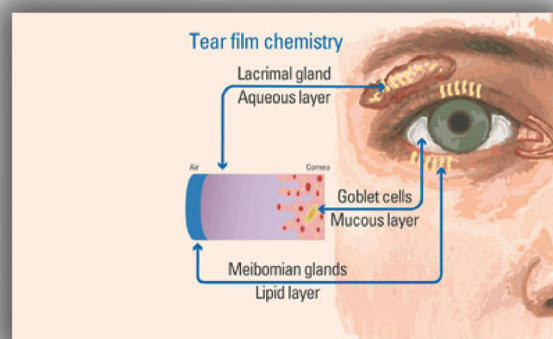
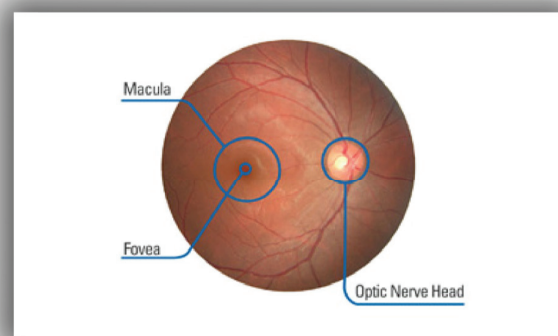

Flexible Content

Add your own images

**REVERSED BACKGROUND
 (available for all optotypes)**



RED / GREEN OVERLAY

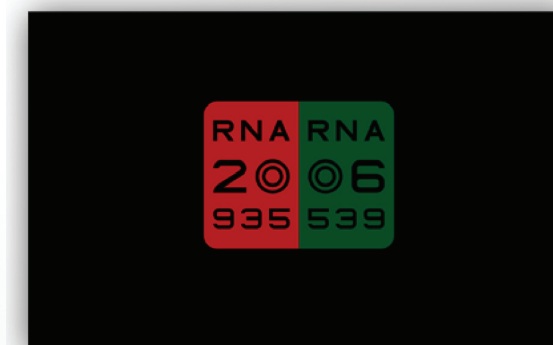

**CROWDING BARS
 (available for all optotypes)**

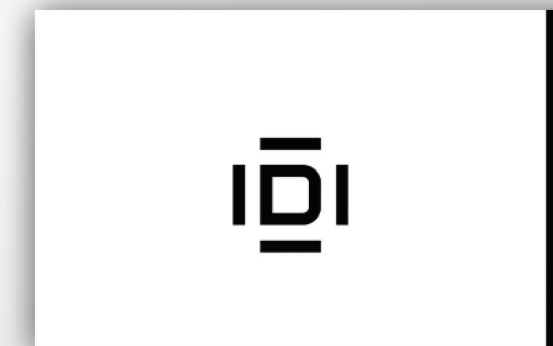

CONTRAST SENSITIVITY

Contrast testing on all optotypes



COLOR TESTS (24 charts available)

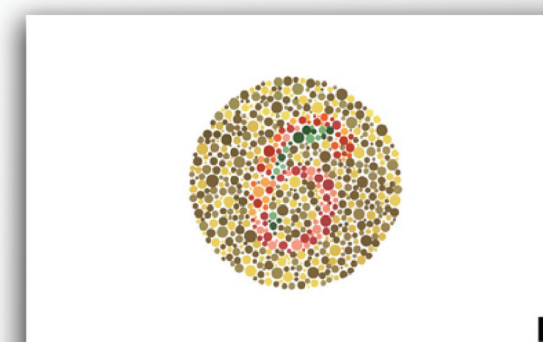
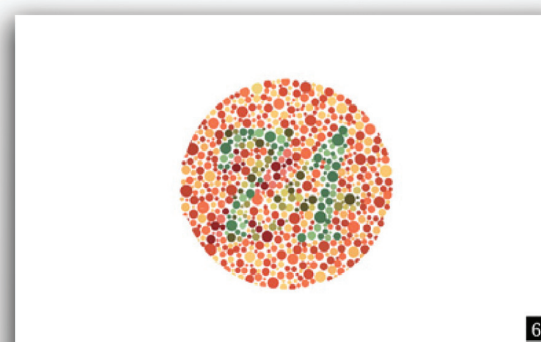
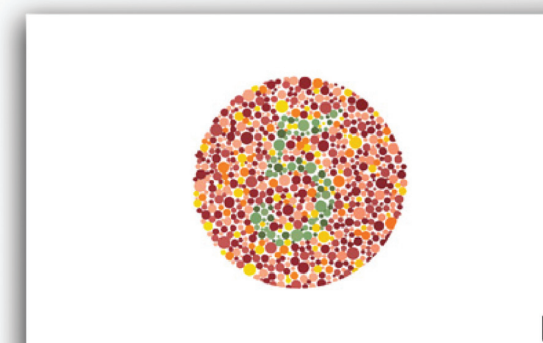
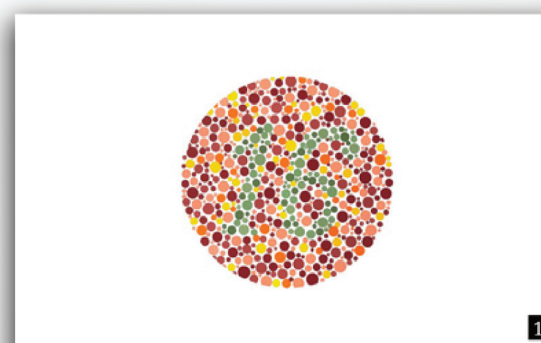



Added Features

INTUITIVE REMOTE CONTROLLER

RANDOMISATION OF OPTOTYPES

CUSTOM SEQUENCES CAN BE PROGRAMMED

MEMORY BUTTON

Memory button allows instant slide selection
of your selected slide.

HIGH RESOLUTION 24" LCD SCREEN

Provides optimal brightness for clear presentation of slides

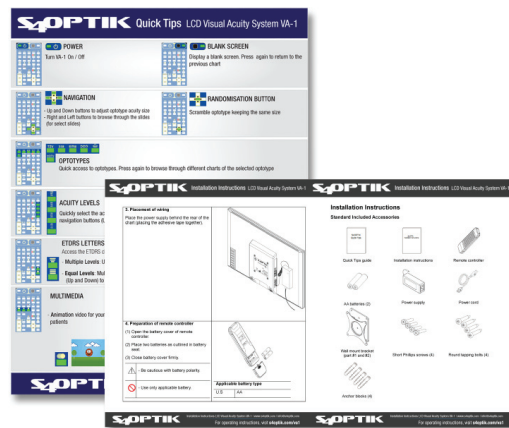
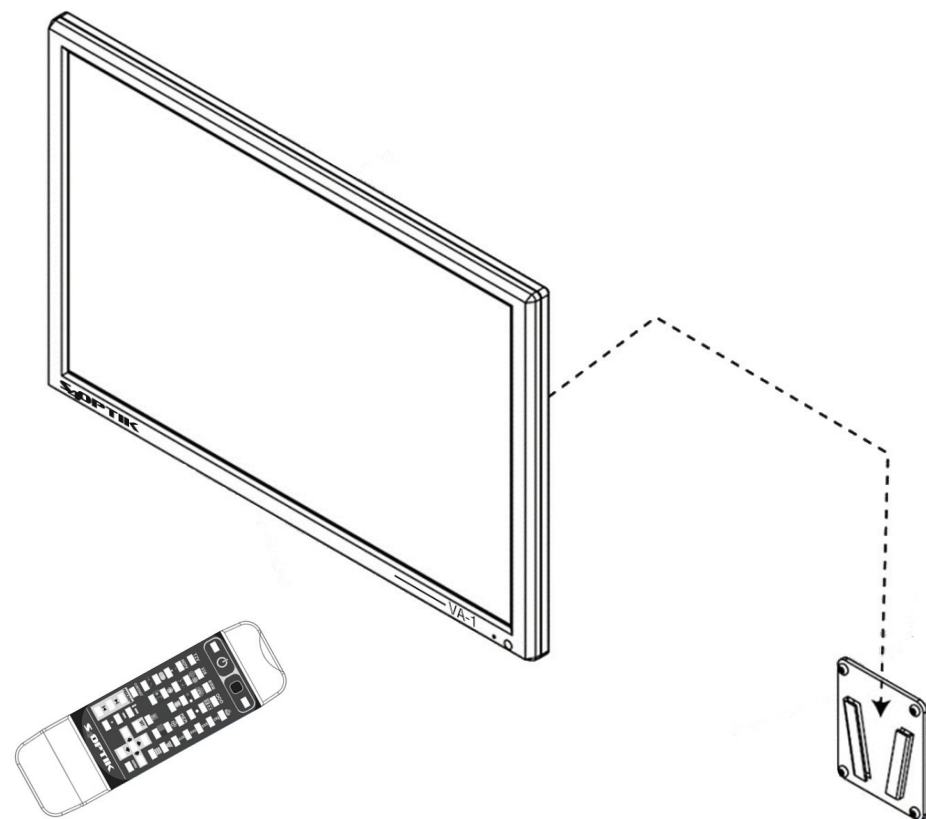

Specifications

Display	24inch WUXGA TFT LCD (1920 X 1200 pixels)
Brightness	Maximum 300cd/m2
Dimension & weight	(W)568 x (H)372 x (D)54mm, Approximately 4.0Kg
Power supply	DC 12V 5A
Measuring distance	9 feet to 26 feet (2.7 to 8 meters)
External interface	4x USB, 1x RS-232, 1x Ethernet(10/100)

About S4OPTIK

Modern Design, Quality Materials, Exceptional Value.

Understanding the unique needs of eye care practices all over the world, S4OPTIK delivers extraordinary value in high quality diagnostic equipment and accessories. With modern designs to enhance your office environment, competitive prices to help you manage your costs, and an industry leading warranty, S4OPTIK eye care instruments help you deliver the very best in patient care. Contact us today for pricing

BR-VA-1-EN-03/17-1.02